

# CONTROL VALVE

## PN40

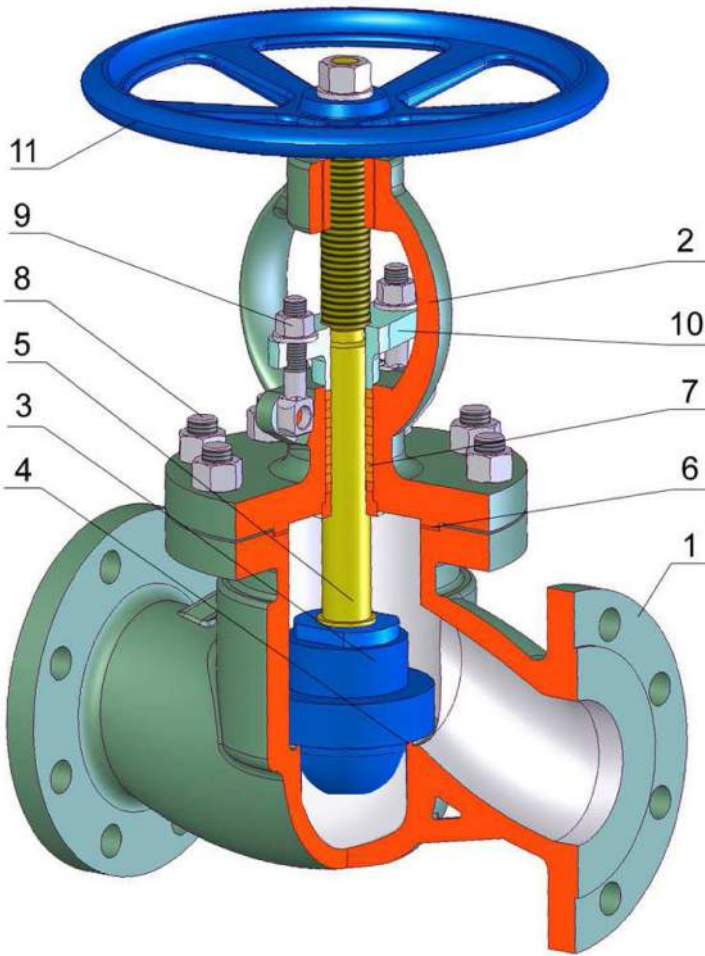

<b>TYPE</b>	<b>V41</b>
<b>Nominal pressure/ номинальное давление</b>	<b>PN 40</b>
<b>Nominal size/ номинальный размер</b>	<b>DN 15 – 150</b>

<b>Design / конструкция</b>	<b>EN 13709</b>
Flanges / фланцы	EN 1092-1
Face-to-face/ стр.длина	DIN 3202
Testing/ испытания	EN 12266-1
Pressure/Temperature Давление / Температура	EN 12516-1

<b>Operation / управление</b>	
1	Handwheel/ маховик
3	Electric actuator /электропривод
4	Pneumatic actuator /пневмопривод

		<b>Trim</b>		
		<b>1</b>	<b>5</b>	<b>8</b>
3	Wedge facing /уплотн.поверх.диска	13 Cr	Stellite 6	13 Cr
4	Seat facing /уплотн.поверх.седла	13Cr	Stellite 6	Stellite 6

Pos	Part / деталь	<b>Material / материал</b>			
		<b>-29 - +400 °C</b>	<b>-20 - +593 °C</b>	<b>-47 - +340 °C</b>	<b>-70 - +350 °C</b>
		<b>DIN (ASTM)</b>	<b>DIN (ASTM)</b>	<b>DIN (ASTM)</b>	<b>DIN (ASTM)</b>
1	Body / корпус	C22.8 (A105) GS-C25 (WCB)	13CrMo44 (F11) GS-17CrMo5-5 (WC6)	TSTE 355 (LF2) GS-20Mn5 (LCB)	X5CrNi18-9 (F304) GX5CrNi 18-9 (CF8)
2	Bonnet / крышка	C22.8(A105) GS-C25 (WCB)	13CrMo44(F11) GS-17CrMo5-5 (WC6)	TSTE 355 (LF2) GS-20Mn5 (LCB)	X5CrNi18-9(F304) GX5CrNi 18-9 (CF8)
3	Disc / диск	X10Cr13(410)/ weld-on	X10Cr13(410)/ weld-on	X5CrNi18-9(F304)/ weld-on	X5CrNi18-9(F304)/ weld-on
4	Seat /седло	X10Cr13 (410)+ weld-on	X10Cr13 (410)+ weld-on	X5CrNi18-9(F304)+ weld-on	X5CrNi18-9(F304)+ weld-on
5	Stem /пиндель	X10Cr13 (410)	X10Cr13 (410)	X5CrNi18-9( F304)	X5CrNi18-9(F304)
6	Sealing /уплотнение	Spiral-graphite/SS	Spiral-graphite/SS	Spiral-graphite/SS	Spiral-graphite/PTFE/SS
7	Packing / сальник	Graphite/PTFE	Graphite/PTFE	Graphite/PTFE	Graphite/PTFE
8	Bolt / болт	A193 B7	A193 B7	A182 L7	A193 B7
9	Nut / гайка	A194 2H	A194 2H	A194 8	A194 2H
10	Packing flange /фланец сальника	C22.8(A105)	X15Cr13(F6)	X15Cr13(F6)	X5CrNi18-9(F304)
11	Hand Wheel / маховик	Carbon steel	Carbon steel	Carbon steel	Carbon steel

Other material specification upon request / другое исполнение по заказу

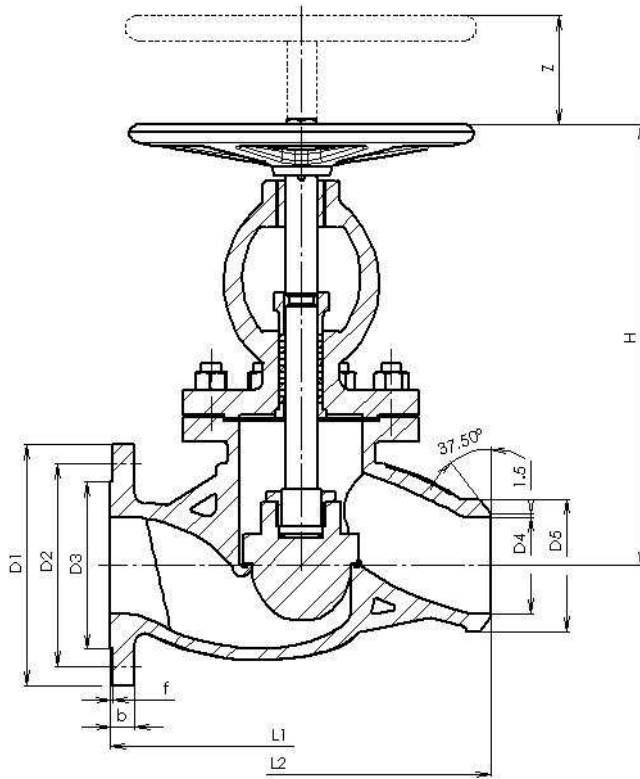

Main and connecting dimensions / главные и присоед. размеры												
<b>DN</b>	<b>15</b>	<b>25</b>	<b>40</b>	<b>50</b>	<b>65</b>	<b>80</b>	<b>100</b>	<b>125</b>	<b>150</b>	...		
<b>D1</b>	95	115	150	165	185	200	220	250	285	...		
<b>D2</b>	65	85	110	125	145	160	180	210	240	...		
<b>D3</b>	47	68	88	102	122	138	158	188	212	...		
<b>D4</b>	According to pipe schedule / согласно размеру трубы											
<b>D5</b>	21,3	33,4	48,3	60,3	73	88,9	114,3	141,3	168,3	.....		
<b>b</b>	14	16	18	18	18	20	20	22	22	..		
<b>f</b>	2	2	2	2	2	2	2	2	2	.		
<b>n</b>	4	4	4	4	4*	8	8	8	8	..		
<b>d</b>	14	14	18	18	18	18	18	18	22	..		
<b>bolt</b>	M12	M12	M16	M16	M16	M16	M16	M16	M20	...		
<b>H</b>	240	285	300	305	354	402	437	496	541	...		
<b>L1</b>	130	160	200	230	290	310	350	400	480	...		
<b>L2</b>	130	160	200	230	290	310	350	400	480	...		
<b>z</b>	12	18	19	21	26	34	38	54	61	..		
<b>Dk</b>	120	160	180	200	200	250	250	300	350	...		
<b>m (kg)</b>	8	12	17	20	30	38	56	75	100	...		

